



LPT 336

Industrial Pressure Transmitter for Technical Gases and H₂ Applications

Welded, Dry
Stainless Steel Sensor

accuracy according to IEC 60770:
0.5 % FSO

Nominal pressure

from 0 ... 16 bar up to 0 ... 1000 bar

Output signal

2-wire: 4 ... 20 mA
others on request

Special characteristics

- ▶ media wetted parts of special stainless steel
- ▶ insensitive to pressure peaks
- ▶ high overpressure capability
- ▶ oil and grease free according to ISO 15001 (e.g. for oxygen applications)

Optional version





- ▶ IS-version zone 0
Ex ia = intrinsically safe for gases and dusts

The industrial pressure transmitter **LPT 336** was especially developed for hydrogen applications and can also be used with other technical gases (e.g. oxygen).

This is achieved by using an alloy based on 316L which prevents hydrogen embrittlement of the media-wetted parts. Level of hydrocarbon and particle contamination are significantly reduced by special treatment during production and cleaning.

An IS- version is optionally available for explosion-protected applications zone 0 / 20.

Preferred areas of use are

-  Technical gases
-  Hydrogen
-  Fuel cell
-  Medical technology

Input pressure range											
Nominal pressure gauge	[bar]	16	25	40	60	100	160	250	400	600	1000
Overpressure	[bar]	50	50	80	120	200	320	500	800	1200	1500
Burst pressure \geq	[bar]	125	125	200	300	500	800	1250	2000	2000	3000 ¹
Vacuum resistance		unlimited									
¹ UL confirmed max. burst pressure 2420 bar											
Output signal / Supply											
Standard		2-wire: 4 ... 20 mA / $V_S = 8 \dots 32 V_{DC}$									
Option IS-protection		2-wire: 4 ... 20 mA / $V_S = 10 \dots 28 V_{DC}$									
Performance											
Accuracy ²		$\leq \pm 0.5\%$ FSO									
Permissible load		$R_{max} = [(V_S - V_{Smin}) / 0.02 A] \Omega$									
Influence effects		supply: 0.05 % FSO / 10 V load: 0.05 % FSO / k Ω									
Long term stability		$\leq \pm 0.2\%$ FSO / year at reference conditions									
Response time		≤ 10 msec									
² accuracy according to IEC 60770 – limit point adjustment (non-linearity, hysteresis, repeatability)											
Thermal effects (offset and span)											
Thermal error		$\pm 0.2\%$ FSO / 10 K									
in compensated range		-25 ... 85 °C									
Permissible temperatures											
Permissible temperatures		medium: -40 ... 125 °C electronics / environment: -40 ... 100 °C storage: -40 ... 85 °C									
Electrical protection											
Short-circuit protection		permanent									
Reverse polarity protection		no damage, but also no function									
Electromagnetic compatibility		emission and immunity according to EN 61326									
Mechanical stability											
Vibration		20 g RMS (25 ... 2000 Hz)	according to DIN EN 60068-2-6								
Shock		500 g / 1 msec	according to DIN EN 60068-2-27								
Materials											
Housing		stainless steel 316L (1.4404)									
Pressure port, sensor, diaphragm		stainless steel 316L (1.4435)									
Seals		none (welded)									
Media wetted parts		pressure port, sensor, diaphragm									
Explosion protection											
Approvals DX19-DMP 336		IBExU 10 ATEX 1068 X / IECEx IBE 12.0027X zone 0: II 1G Ex ia IIC T4 Ga zone 20: II 1D Ex ia IIIC T 135°C Da									
Safety technical maximum values		$U_i = 28 V_{DC}$, $I_i = 93$ mA, $P_i = 660$ mW, $C_i \approx 0$ nF, $L_i \approx 0$ μ H, the supply connections have an inner capacity of max. 27 nF									
Permissible temperatures for environment		in zone 0: -20 ... 60 °C with p_{atm} 0.8 bar up to 1.1 bar in zone 1 or higher: -20 ... 70 °C									
Connecting cables (by factory)		cable capacitance: signal line/shield also signal line/signal line: 160 pF/m cable inductance: signal line/shield also signal line/signal line: 1 μ H/m									
Miscellaneous											
Current consumption		max. 25 mA									
Weight		approx. 140 g									
Installation position		any									
Operational life		$p_N \leq 600$ bar: 100 million load cycles					$p_N > 600$ bar: 10 million load cycles				
CE-conformity		EMC Directive: 2014/30/EU Pressure Equipment Directive: 2014/68/EU (module A) ³									
ATEX Directive		2014/34/EU									
³ This directive is only valid for devices with maximum permissible overpressure > 200 bar.											
Purity regarding residual particles / greases											
Oil and grease free version		residual particles: no particles > 100 μ m (based on 10 dm ²) residual greases: residual grease content < 0.2 mg/dm ²									

Wiring diagram

2-wire-system (current)

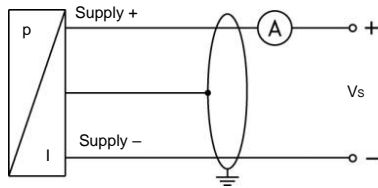

Pin configuration

Electrical connections	M12x1 / metal (4-pin)		cable colours (IEC 60757)
supply +	1		WH (white)
supply -	2		BN (brown)
Shield	4		GNYE (green-yellow)

Electrical connections (dimensions mm / in)

standard

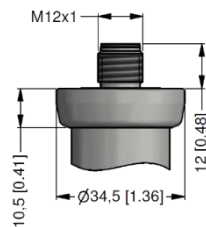

M12x1 4-pin (IP 67)

option

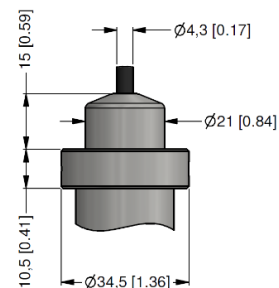

cable outlet with PVC cable (IP 67) ⁴

⁴ standard: 2 m PVC cable without ventilation tube (permissible temperature: -5 ... 70 °C)

Mechanical connections (dimensions mm / in)

standard

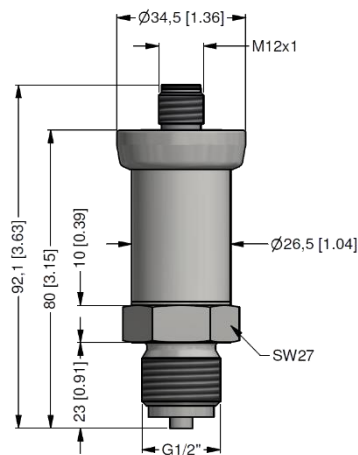

G1/2" EN 837

options

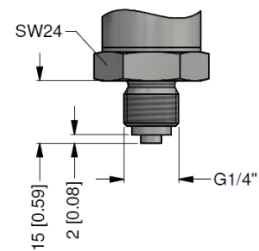

G1/4" EN 837
pN ≤ 600 bar

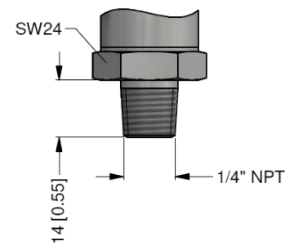

1/4" NPT

⇒ metric threads and different types on demand

© 2021 DRUCK & TEMPERATUR Leitenberger GmbH – The specifications given in this document represent the state of engineering at the time of publishing. We reserve the right to make modifications to the specifications and materials.

